

# bopita®

ASSEMBLY INSTRUCTION  
MONTAGE HANDLEIDING  
MONTAGE ANLEITUNG  
NOTICE DE MONTAGE  
MANUAL DE MONTAJE

UK  
NL  
D  
F  
ESP

MODEL  
TYPE  
COLOUR  
ART.CODE

: BRENT  
: PLAYPEN  
: MATT BLACK  
: 1052.12

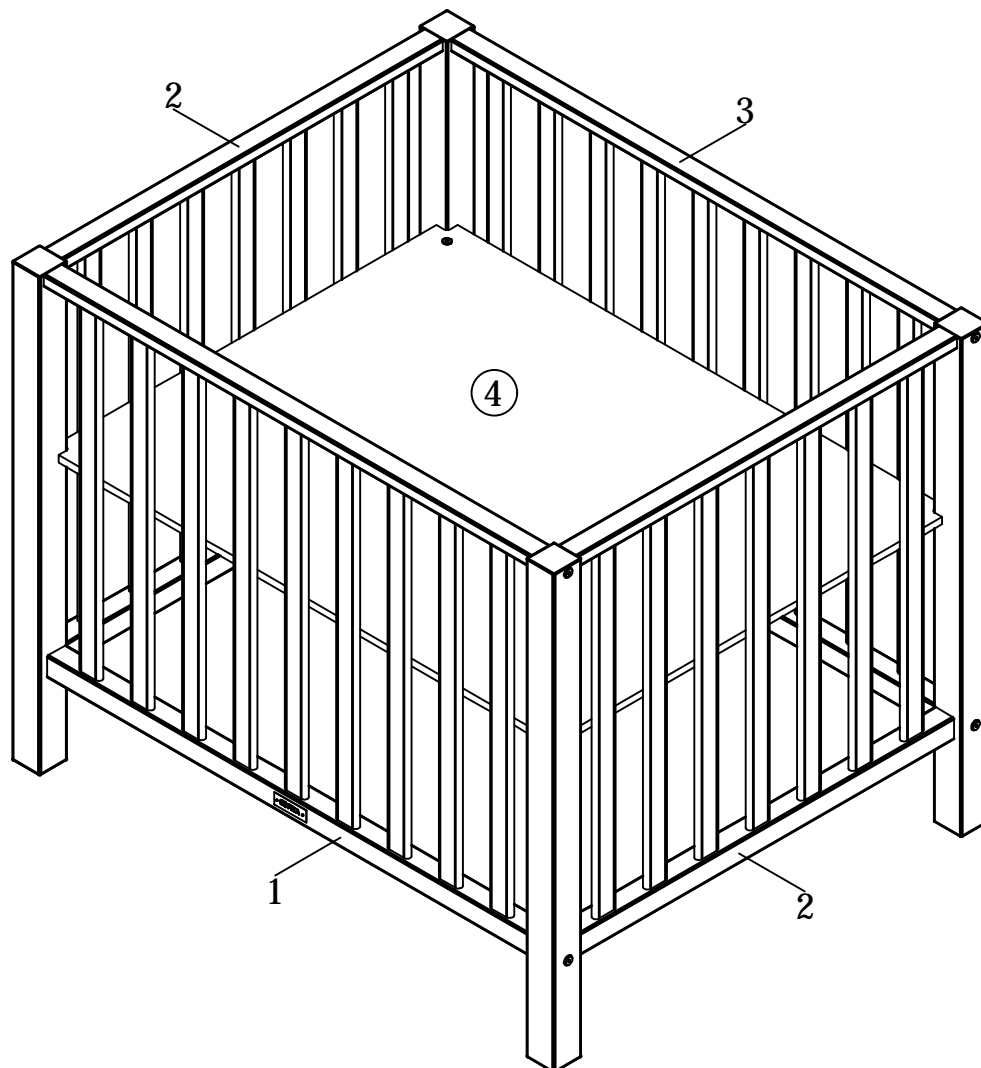









Distributor:

BOPITA  
Energieweg 1  
6662 NS Elst  
The Netherlands

[www.bopita.com](http://www.bopita.com)

26.02.2022.

<p>A</p>  <p>M6X90 8X</p>	<p>B</p>  <p>M6 8X</p>	<p>C</p>  <p>M6X25 4X</p>	<p>D</p>  <p>4X</p>	<p>E</p>  <p>« 6 4X</p>	<p>F</p>  <p>M6 4X</p>
--	---	--	--	--	---

<p>G</p>  <p>SW4 1X</p>	<p>H</p>  <p>« 6X30 4X</p>
--	---

